

MATERIALS LIST

ITEMS	DESCRIPTION	NOTES
A	IRD-40 SECONDARY CONTAINMENT BASIN	

NOTES:

1. TANK IS MANUFACTURED TO ASTM-D-1998 STANDARD.
2. TANK CAPACITY: 40 I.G. (180 L).
3. ALL DIMENSIONS ARE APPROXIMATE.

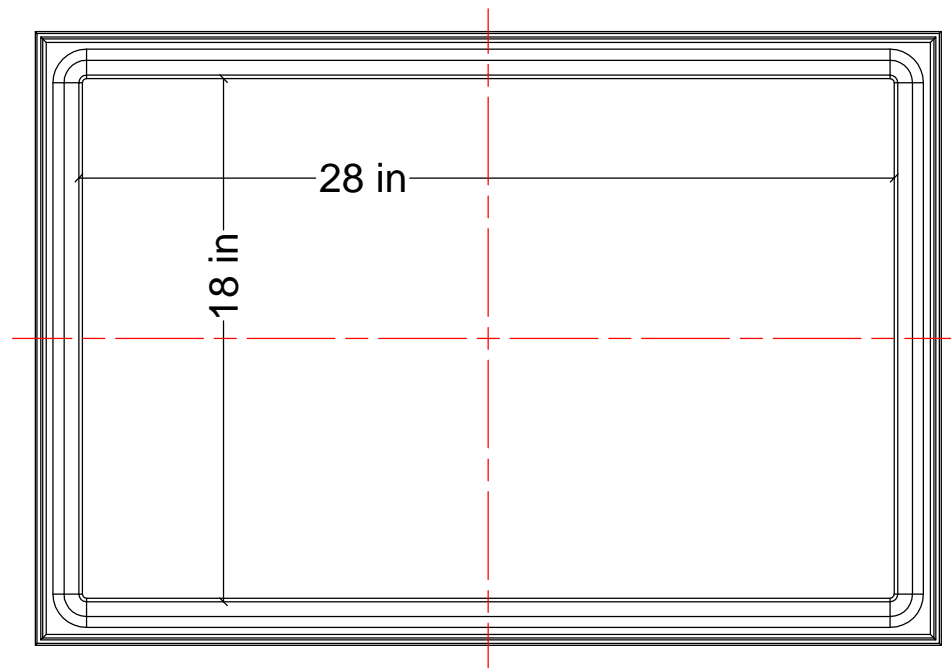

TOP VIEW

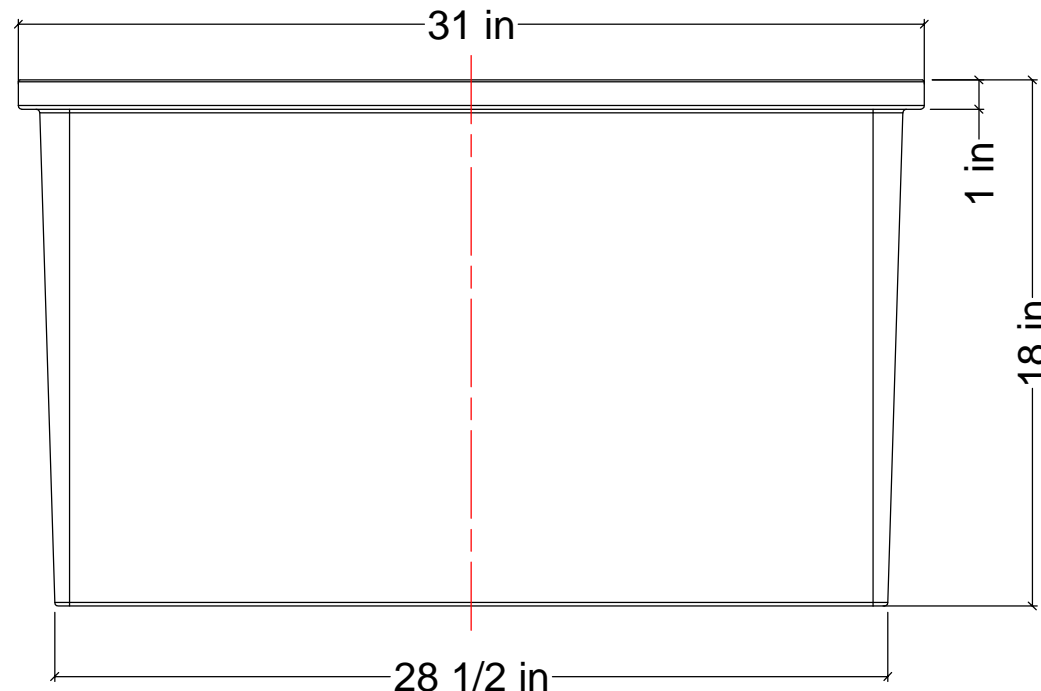
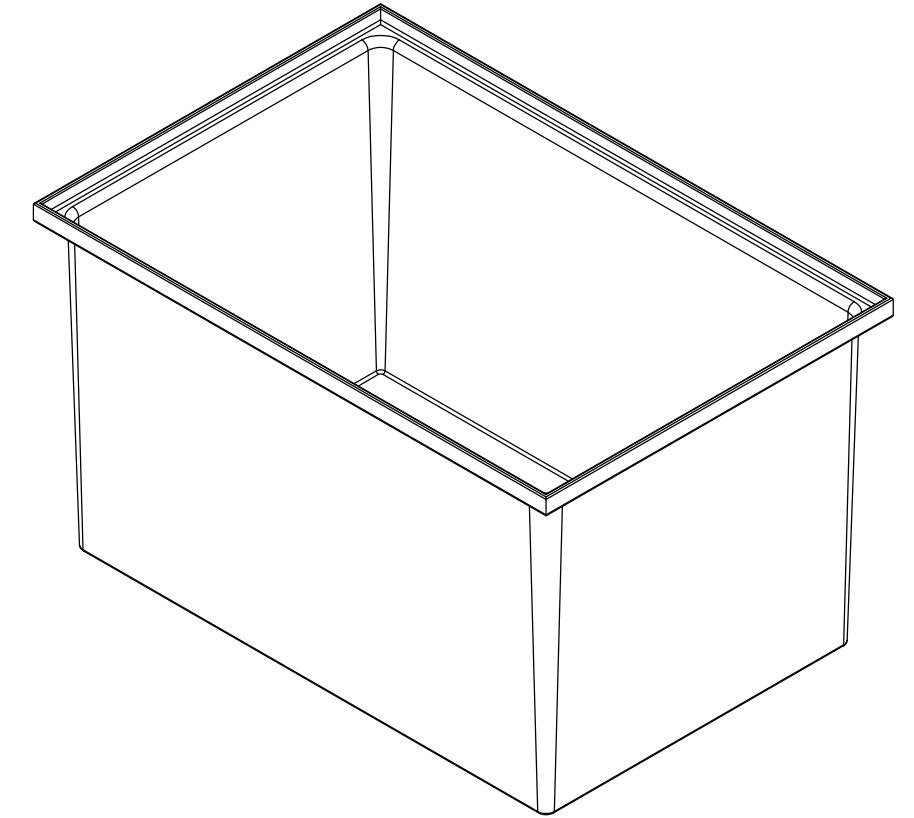

FRONT VIEW

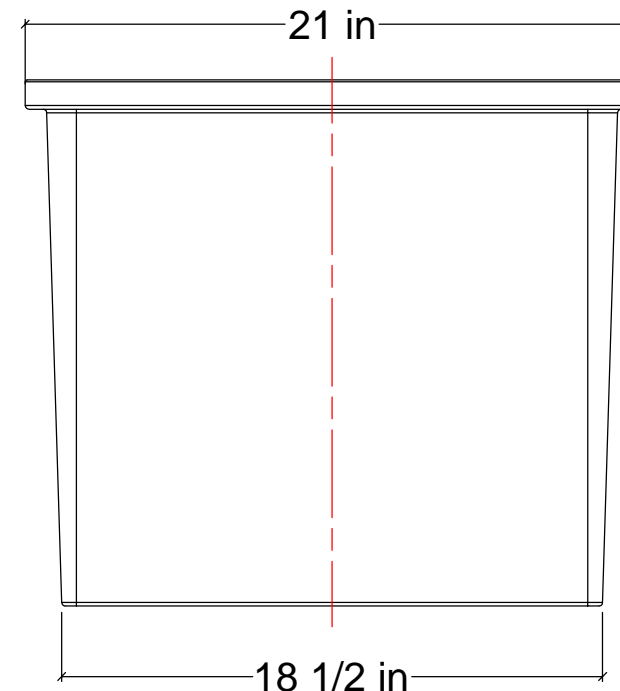

SIDE VIEW

AGRICO PLASTIQUES
450-471-2772

WWW.AGRICOPLASTIQUES.COM

RÉSERVOIR IRD40

CAPACITÉ DE:
40 GALLONS IMPÉRIAUX
48 GALLONS US
182 LITRES